

TECHNICAL DATA REFERENCE SHEET

Alumaboard® Panels

Alumaboard® is a 6063-T5 extruded aluminum alloy, this particular alloy is most used for architectural products. Alumaboard comes in two different widths and is powder coated with a variety of wood grain or solid color finishes.

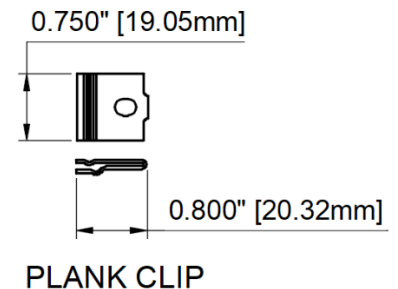
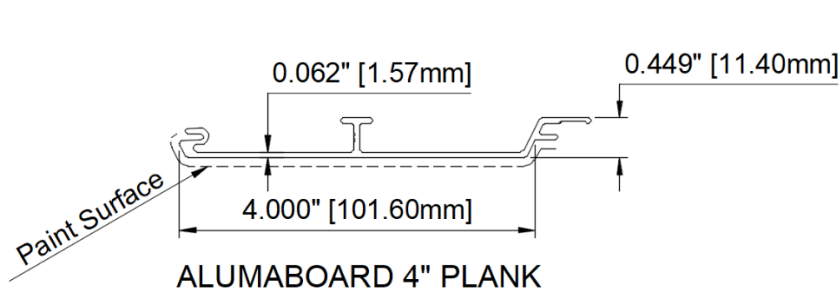
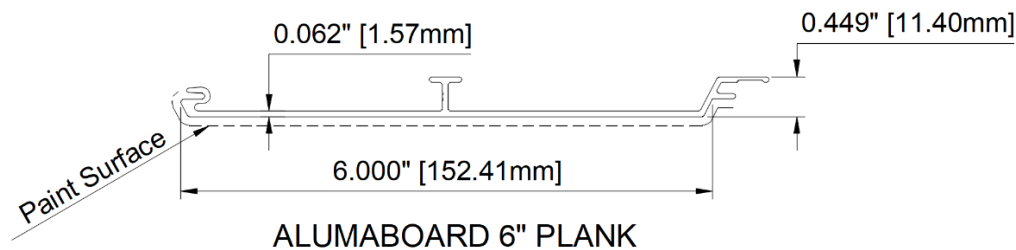
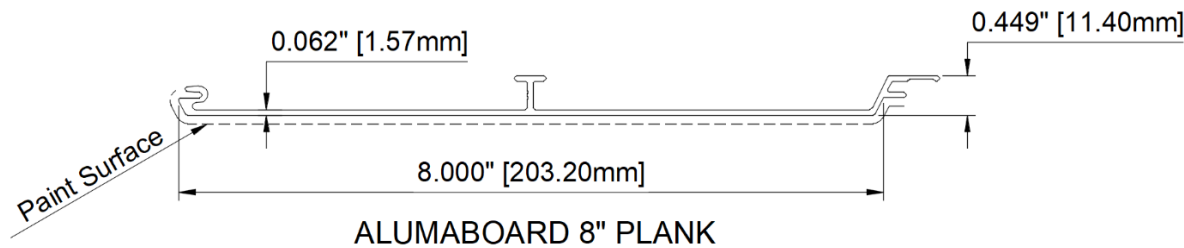
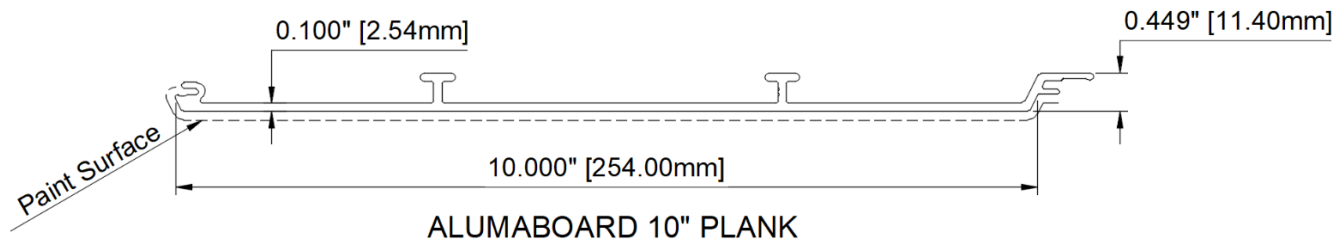

Standard length: 10" plank is 16'-0".

Standard length: 4", 6", and 8" planks is 24'-0".

Standard length: Alumaboard components is 12'-0". (see page 2.)

Custom lengths less than the standard lengths above are available upon request please inquire with a sales representative for additional information.

Alumaboard® Components

Alumaboard® has a variety of extruded aluminum components available that can be painted to match the panels in order to complete an installation. These parts include inside corners, outside corners, window trim, door trim, starters, cap components.

Alumaboard® panels are open-backed and the plank clips which are made from 304-2B x .035" thick stainless steel allow for both thermal expansion and moisture weep which complies with National Building Code Standards for Rainscreen applications by providing a continuous airspace for the entire width of the panel. Clips are fastened at 16" or 32" on center based on design windload criteria.

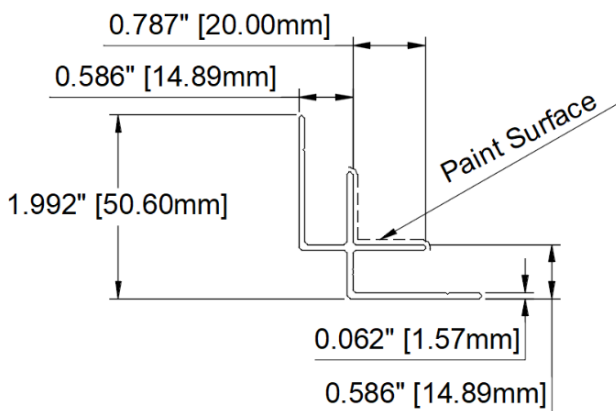

ALUMABOARD INSIDE CORNER

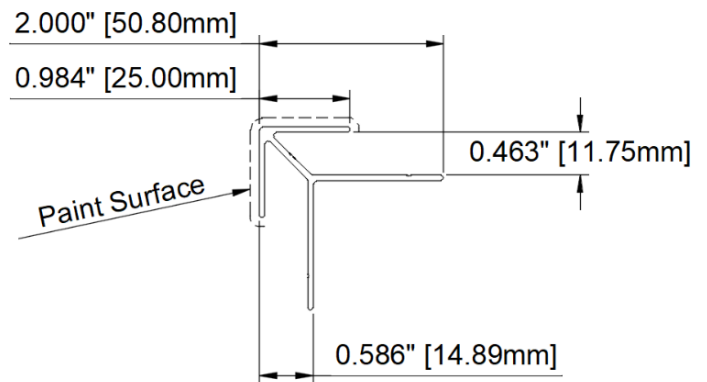

ALUMABOARD OUTSIDE CORNER

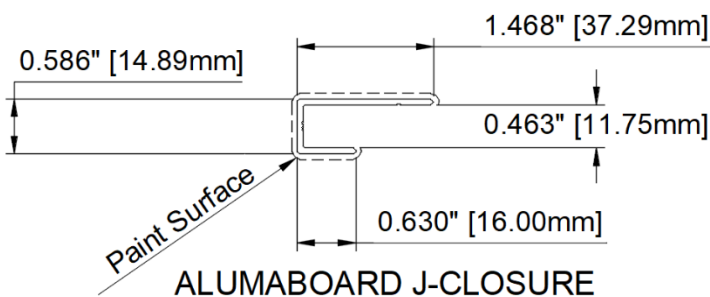

ALUMABOARD J-CLOSURE

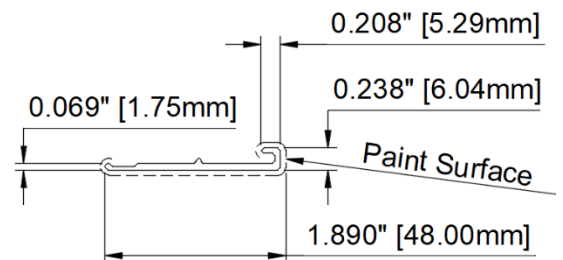

ALUMABOARD STARTER

Alumaboard® Components Cont'd...

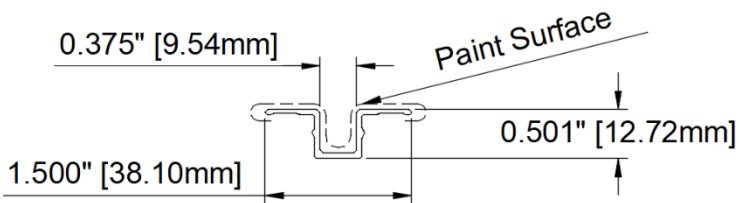

ALUMABOARD JOINT TOP REVEAL

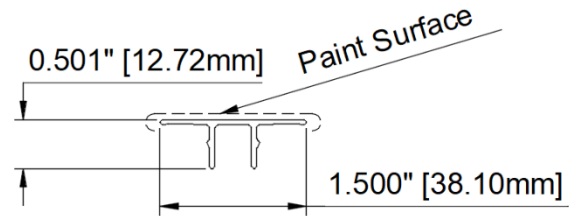

ALUMABOARD JOINT TOP

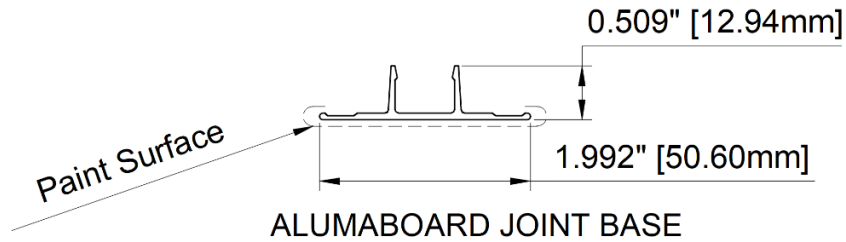

ALUMABOARD JOINT BASE

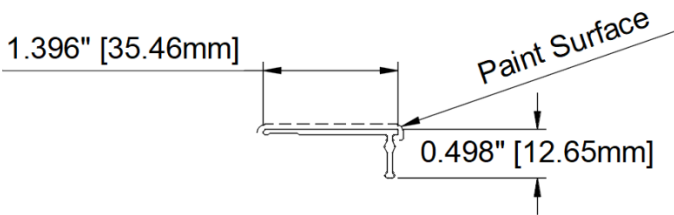

ALUMABOARD EDGE TOP

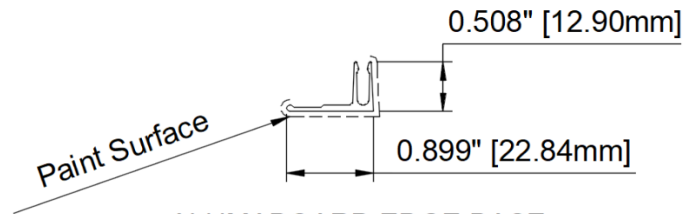

ALUMABOARD EDGE BASE



Alumaboard® Finishes

The pre-treatment chemicals used to prep the Alumaboard for painting are a Chrome Free five stage aluminum pretreatment system, which complies with AAMA 2603, AAMA 2604 and AAMA 2605 Superior Performance Standard and meets EPA, OSHA, State and Local environmental requirements and contains no chromates, cyanides or other heavy metals. Waste treatment is usually a simple pH neutralization and disposal to the sanitary sewer.

Alumaboard® wood grain finishes are created by means of a US Patented process and coated with an extremely durable Powder Coating which is a blend of polyurethane powder coat mixed with an ink based wood grain pattern that is sublimated into a base powder coat. A light grainy texture may also be applied during the powder coating process to create the aesthetic effect of real wood while offering the longevity and same environmental advantage of powder coated aluminum finishes.

Alumaboard® Test Data

Structural Load Calcs:

Load span charts with CA stamps

Structural Testing:

AAMA 1402-09

Burn Testing:

ASTM E84-16

ASTM E136-16

Paint Finish testing:

AAMA 2603

AAMA 2604

AAMA 2605

