

2529 W. Jackson St.
 Phoenix, AZ 85298
 PHONE: (602) 275-1676
 FAX: (602) 275-1739



ALUMINUM DETAIL ELEVATION

SCALE: NTS

7/24/14

SYSTEM = 1/8" ALUMINUM - AP400

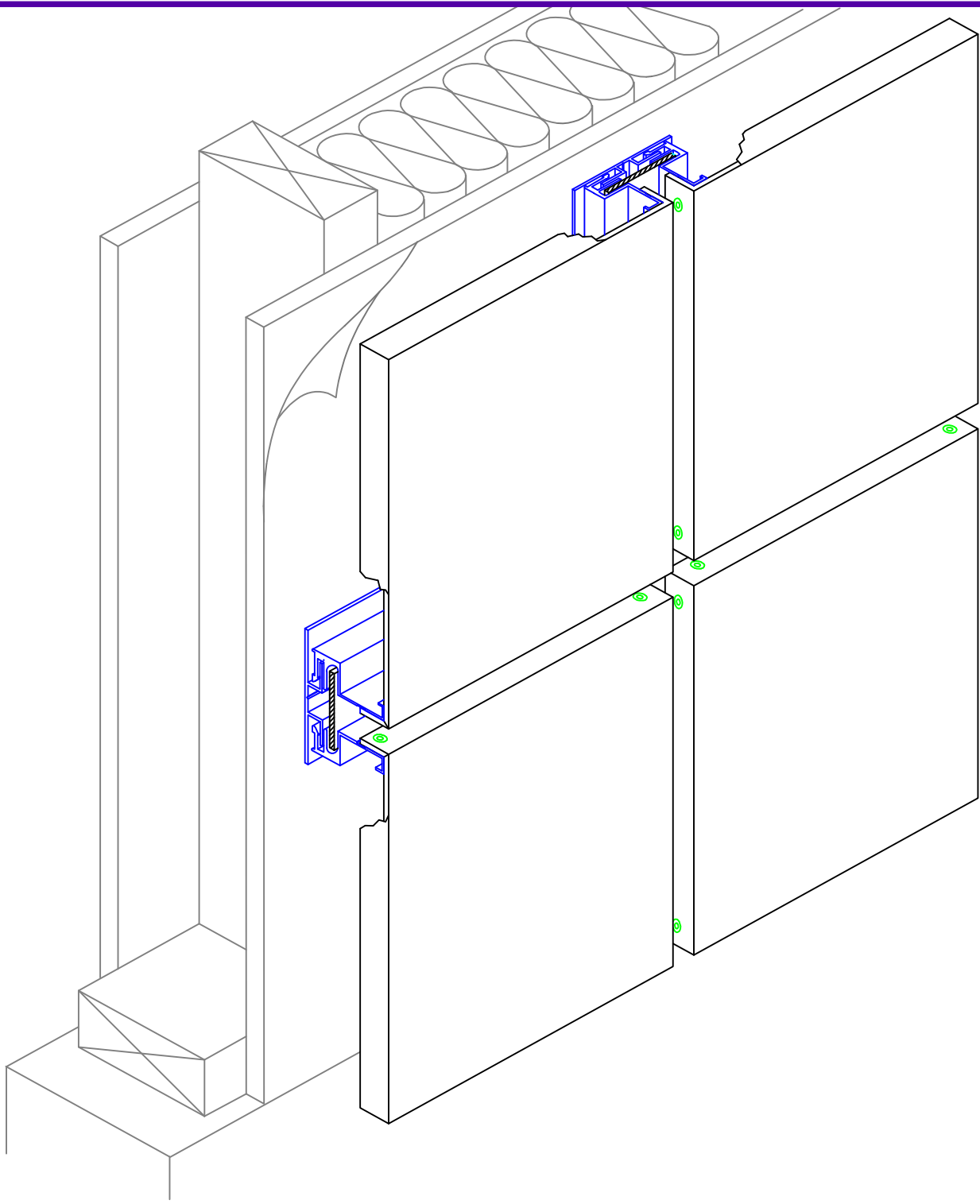

2529 W. Jackson St.
Phoenix, AZ 85298
PHONE: (602) 275-1676
FAX: (602) 275-1739



PANEL ISOMETRIC SKETCH

SCALE: NTS

7/24/14

SYSTEM = 1/8" ALUMINUM - AP400

0

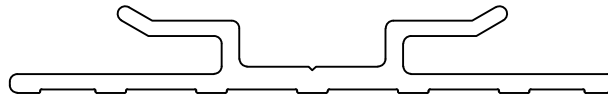

FIELD CLIP EXTRUSION

FIELD OR SHOP CUT TO 6", FIELD MOUNTED
TO SUBSTRATE @ 16" O.C.

W/ 2 - #10 / #12 x 1 1/2" SELF TAPPING STAINLESS SCREWS
APPLY SHIMS BENEATH AS REQUIRED



MODIFIED CLIP EXTRUSION

FIELD CUT TO FIT AS REQUIRED
MOUNTED IN FULL LENGTH SECTIONS @ 16" O.C.
CAN BE USED AT: STARTER, JAMB, SILL, END WALL
#10 / #12 X 1 1/2" SELF TAPPING STAINLESS SCREW



SILL CLIP EXTRUSION

FIELD CUT TO FIT AS REQUIRED
MOUNTED IN FULL LENGTH SECTIONS @ 16" O.C.
CAN BE USED AT: STARTER, JAMB, SILL
#10 / #12 X 1 1/2" SELF TAPPING STAINLESS SCREW

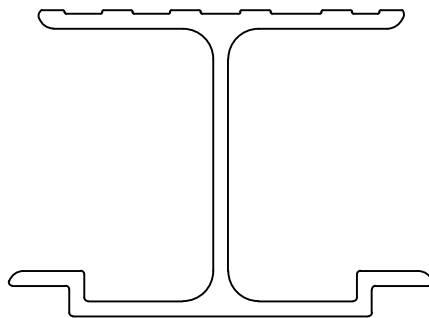

STIFFENER EXTRUSION

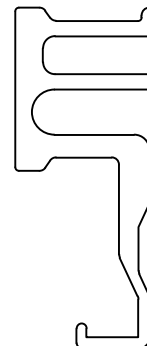

FRAME EXTRUSION

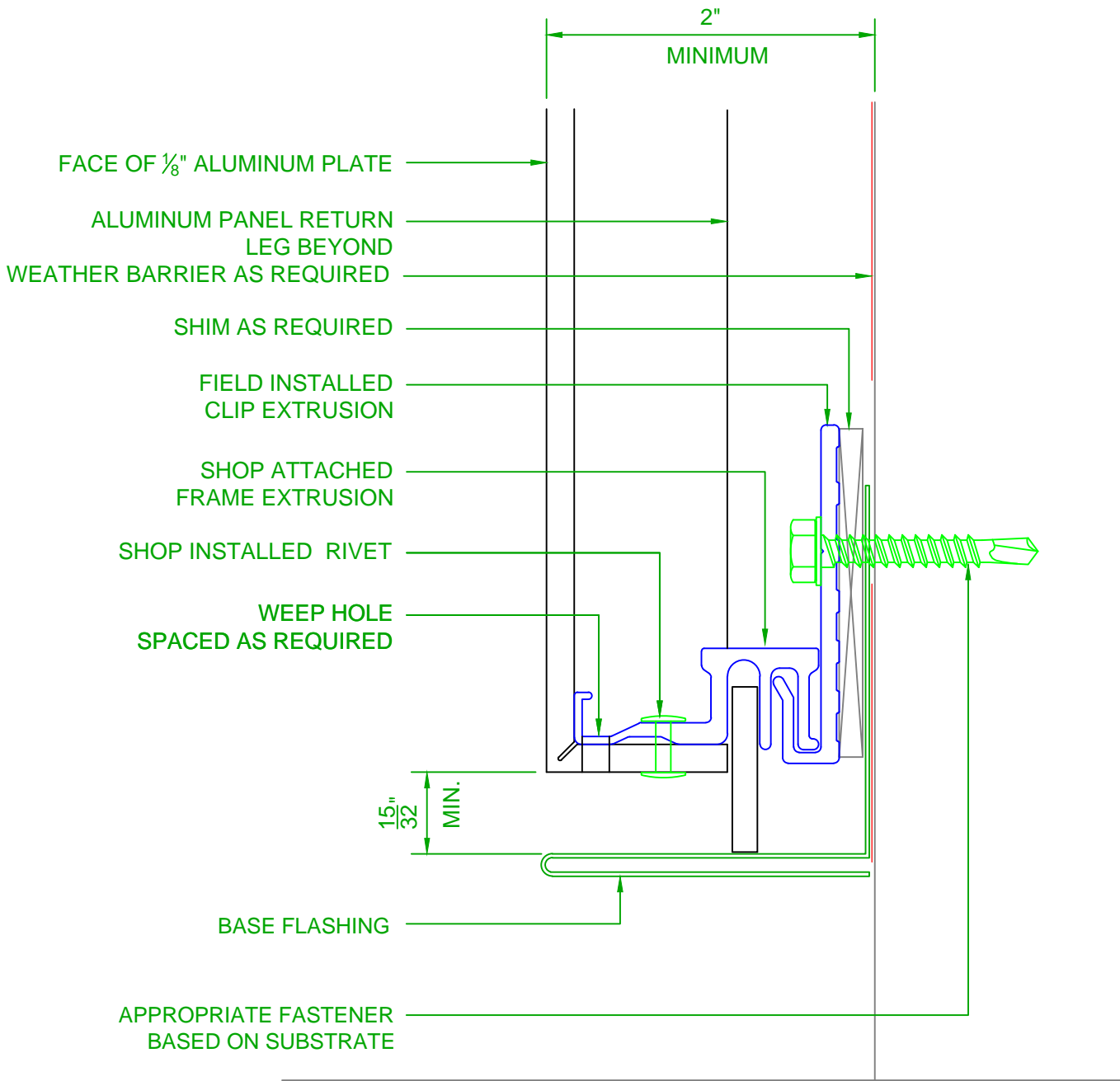

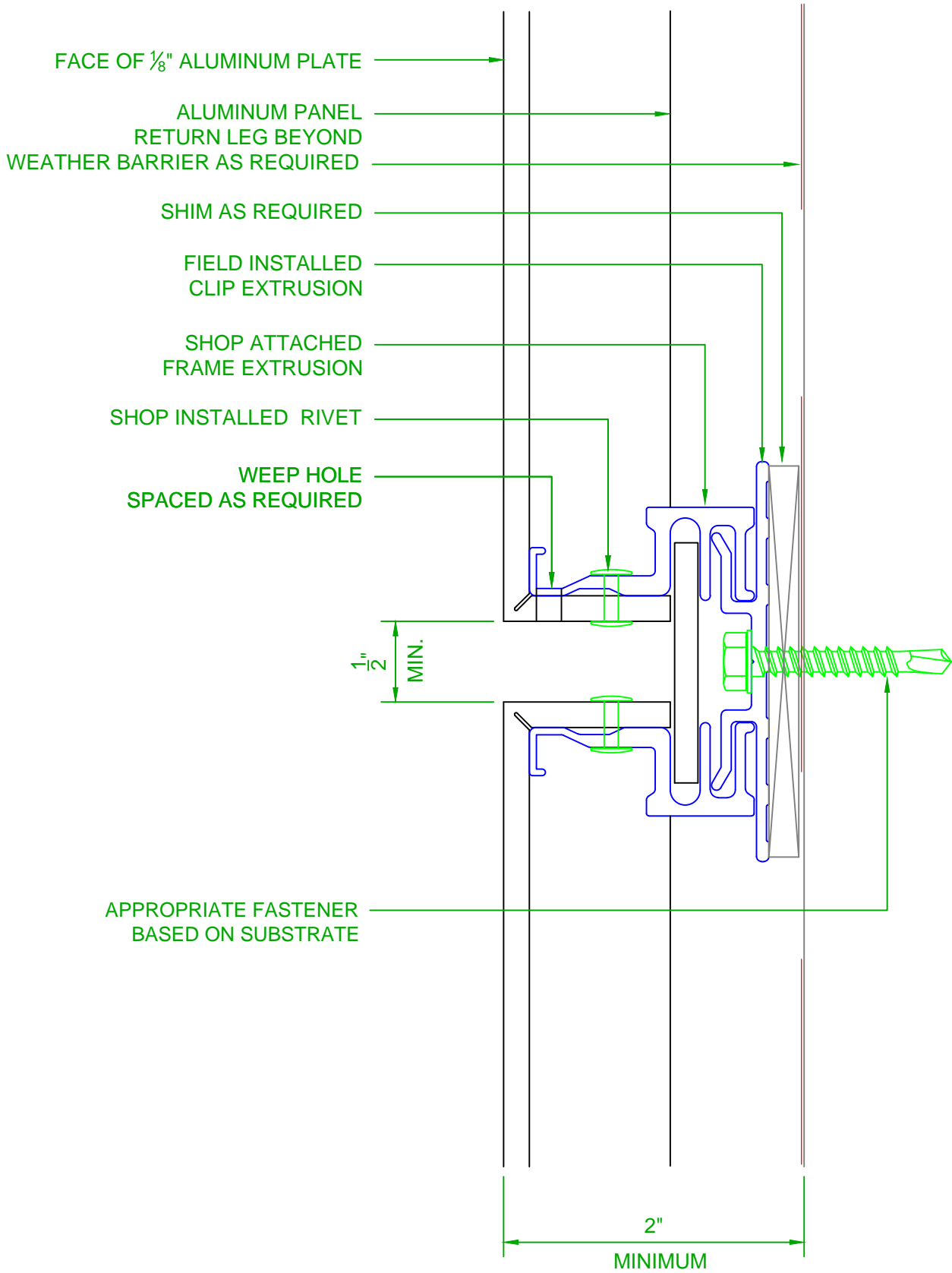

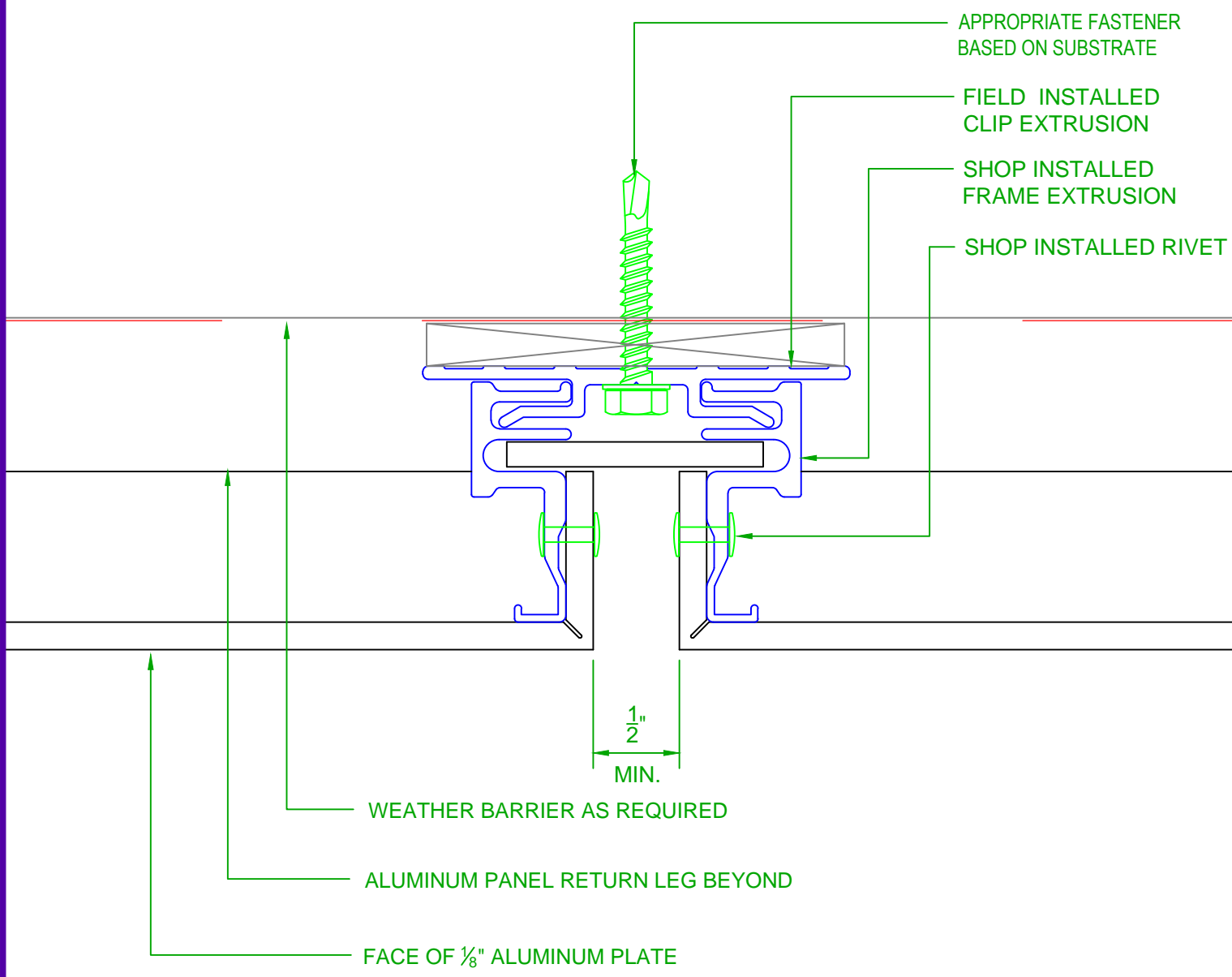

2529 W. Jackson St.
 Phoenix, AZ 85298
 PHONE: (602) 275-1676
 FAX: (602) 275-1739

TYP VERTICAL REVEAL

3A

SCALE: NTS

7/24/14

SYSTEM = 1/8" ALUMINUM - AP400

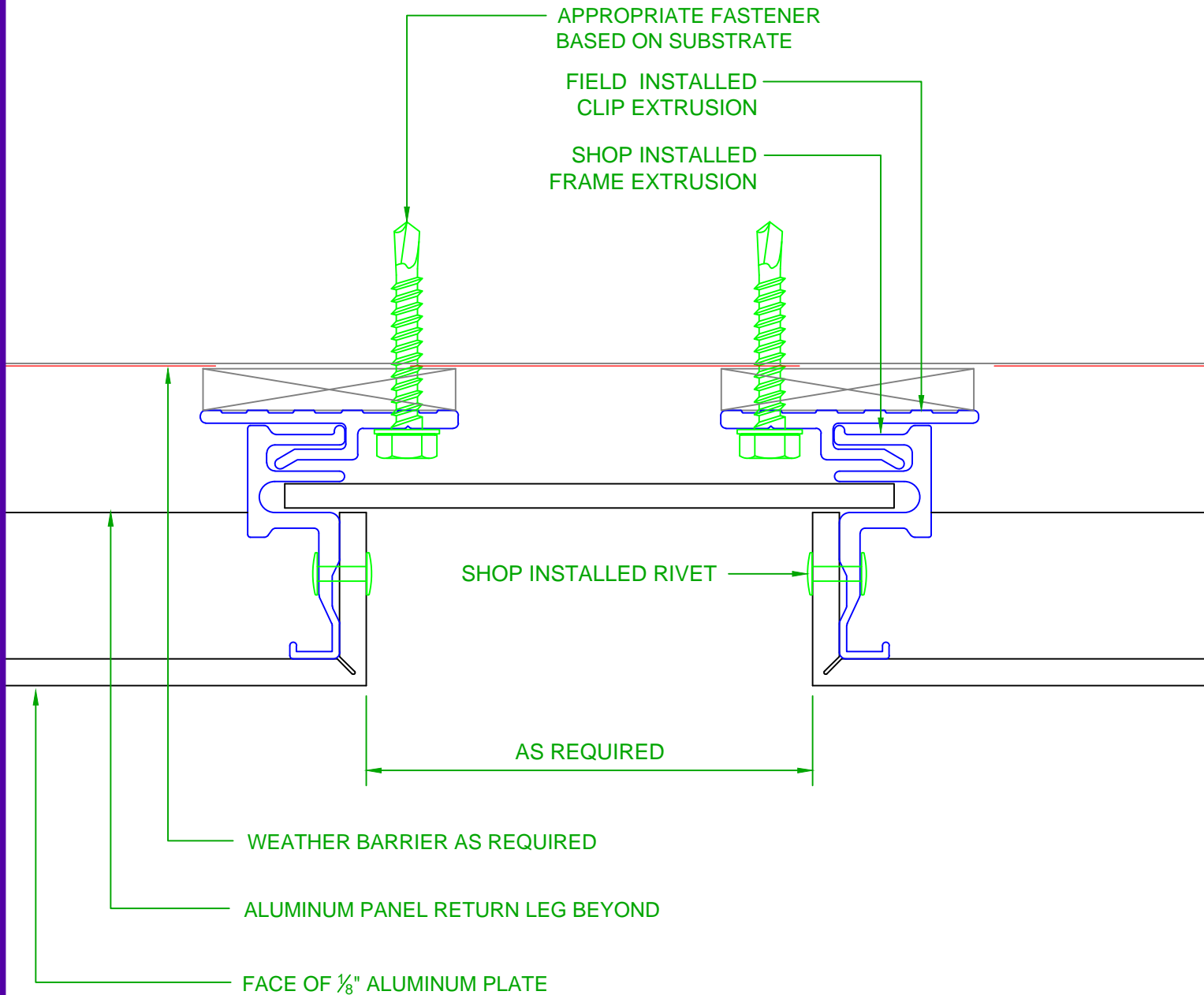

2529 W. Jackson St.
Phoenix, AZ 85298

PHONE: (602) 275-1676
FAX: (602) 275-1739

ALTERNATE REVEAL

SCALE: NTS

7/24/14

SYSTEM = 1/8" ALUMINUM - AP400

3B

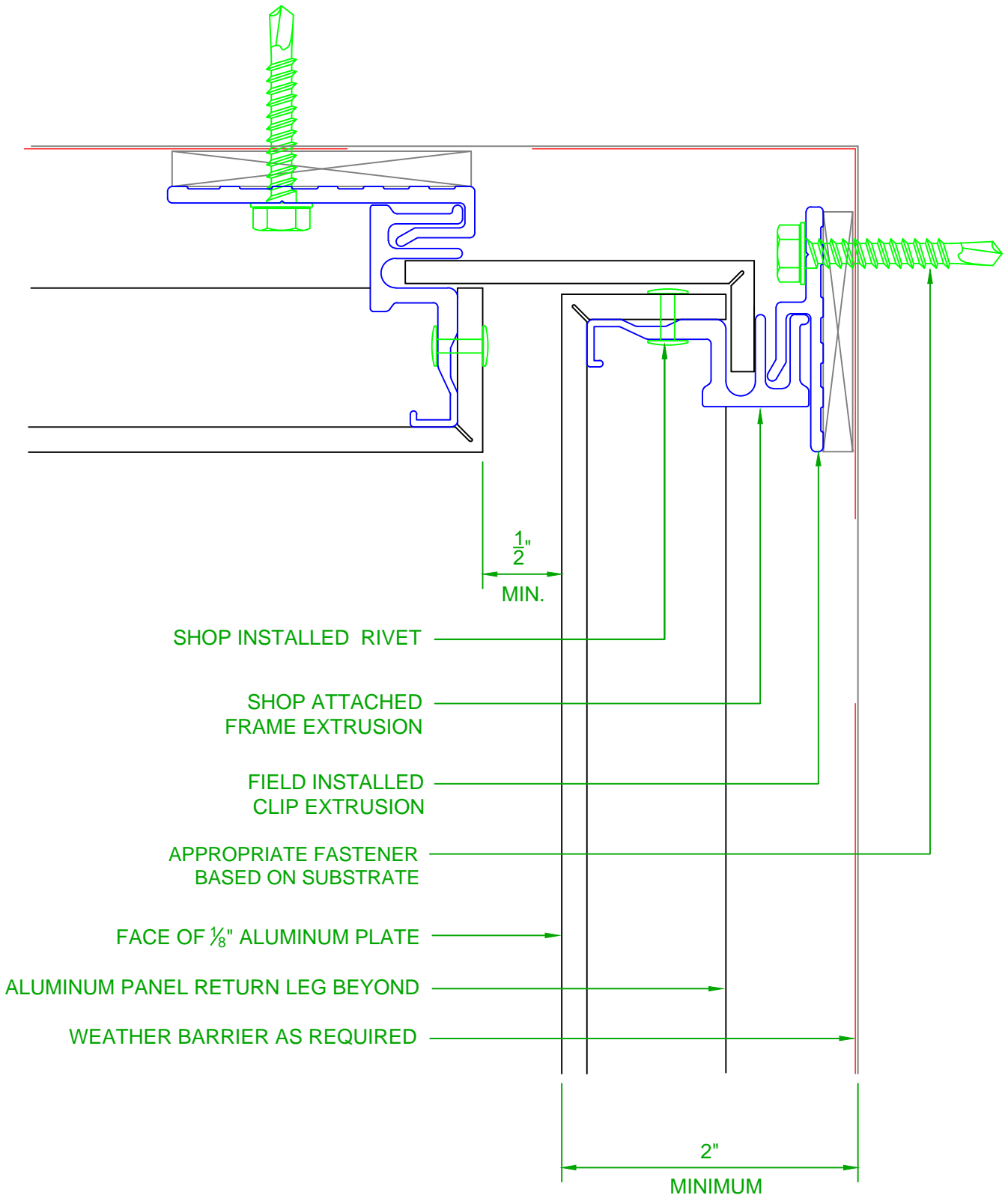

TYP. OUTSIDE CORNER DETAIL

SYSTEM = 1/8" ALUMINUM - AP400

7/24/14

SCALE: NTS

2529 W. Jackson St.
Phoenix, AZ 85298
PHONE: (602) 275-1676
FAX: (602) 275-1739

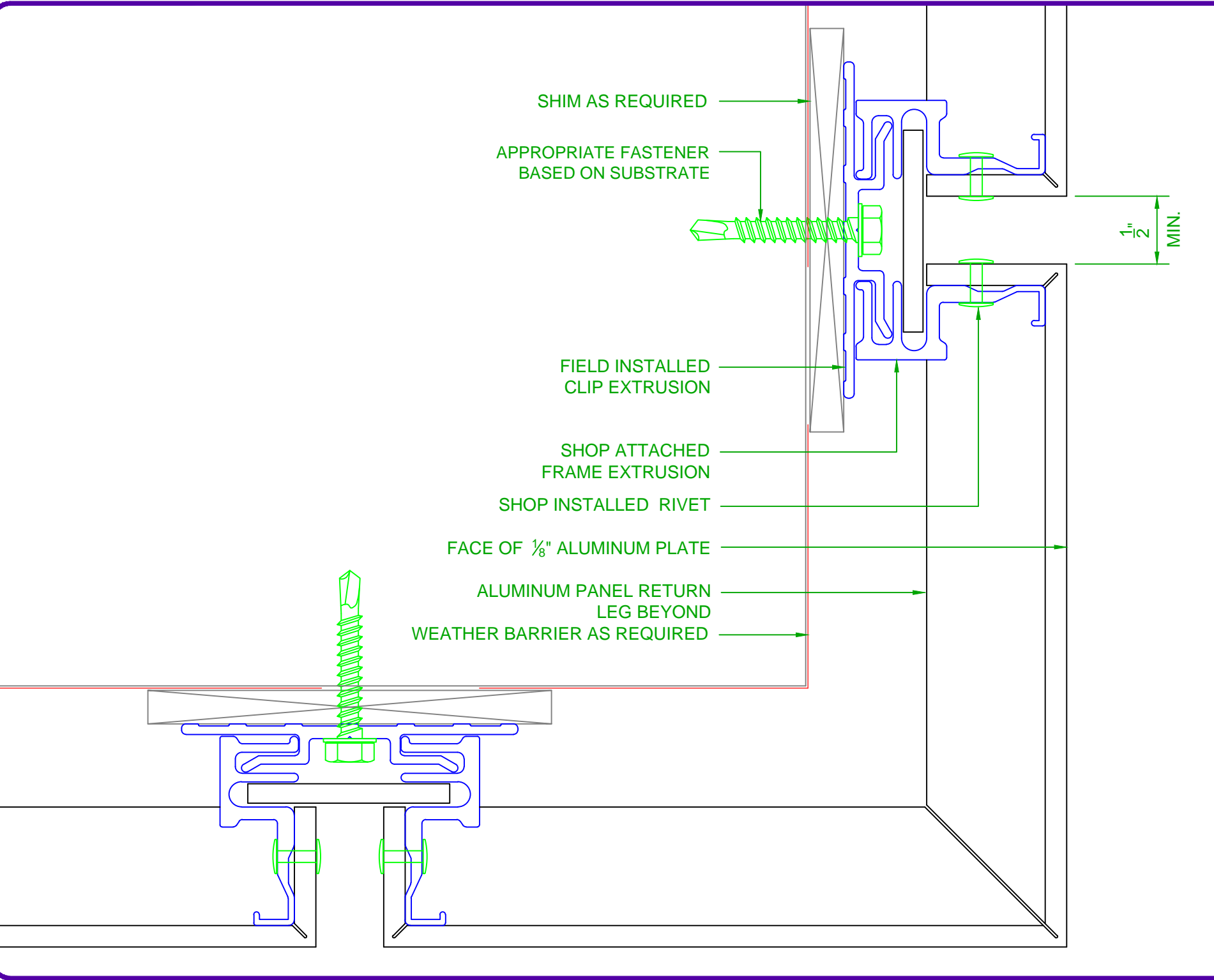

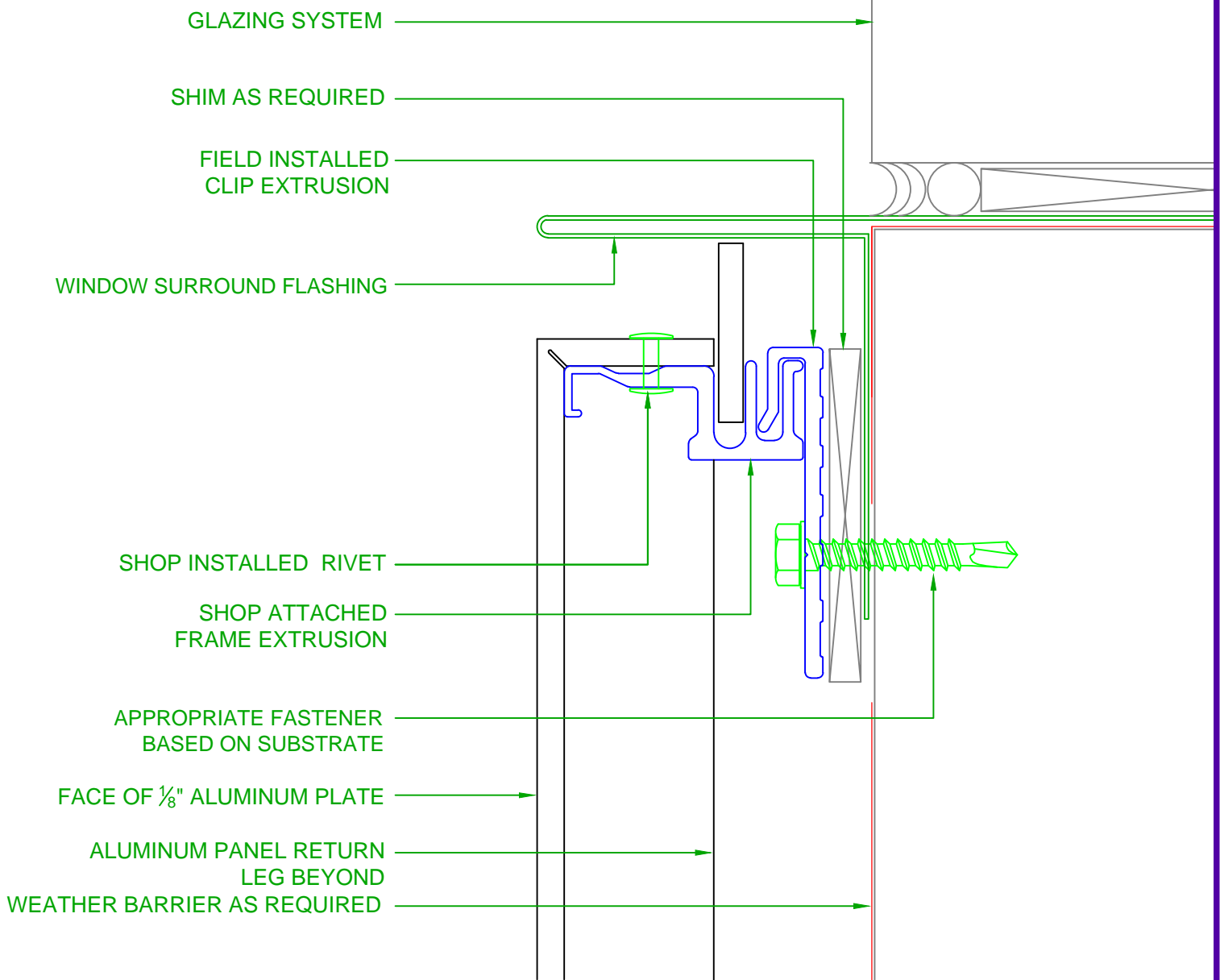

2529 W. Jackson St.
Phoenix, AZ 85298

PHONE: (602) 275-1676
FAX: (602) 275-1739

TYP. WINDOW SURROUND DETAIL

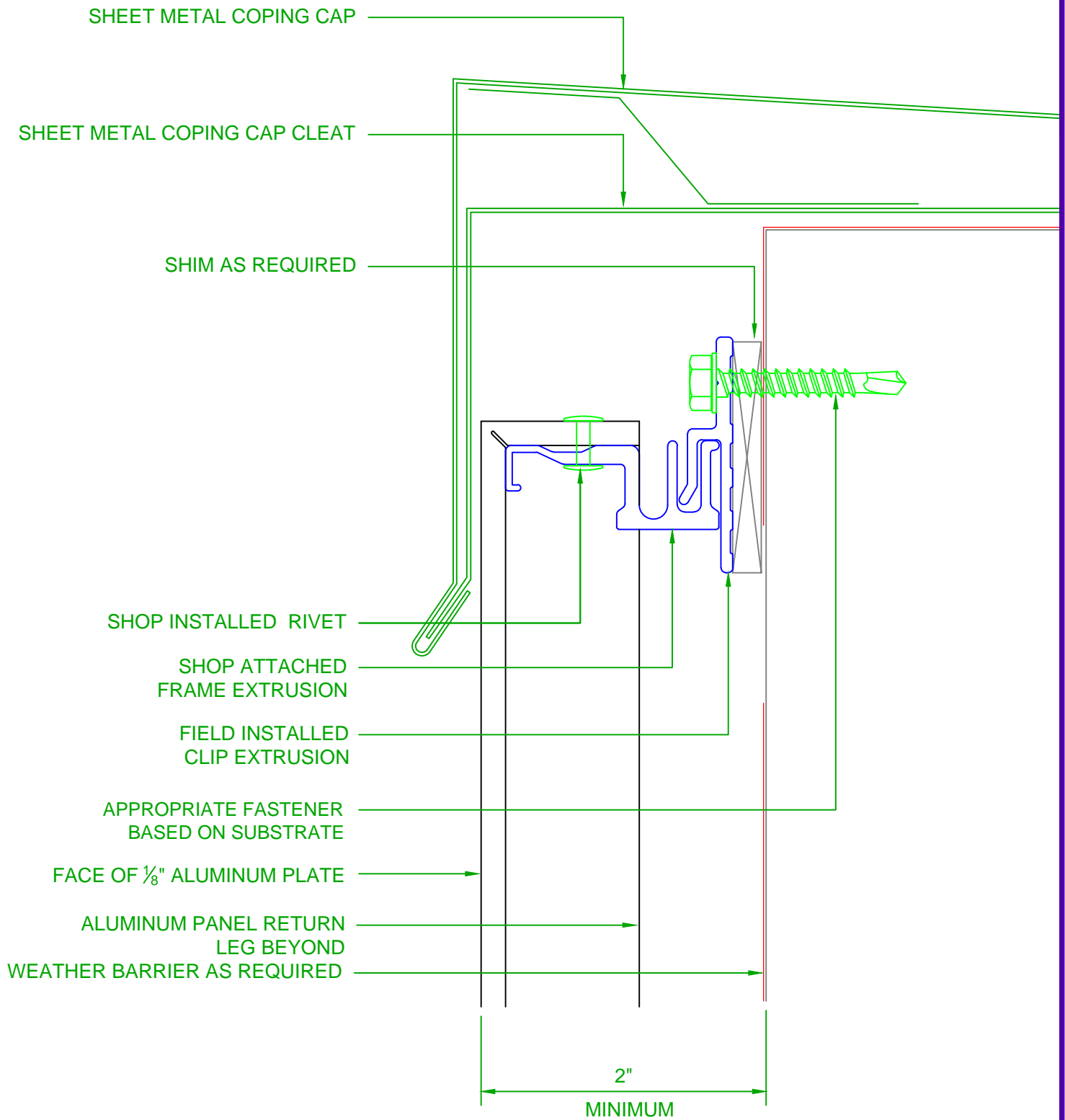

TYP. ACM COPING CAP DETAIL

SYSTEM = 1/8" ALUMINUM - AP400

7/24/14

SCALE: NTS

2529 W. Jackson St.
Phoenix, AZ 85298
PHONE: (602) 275-1676
FAX: (602) 275-1739

