

**Product Information:**

- Architectural Soffit and Wall Application
- Applied over open framing or solid substrate
- Finishes: Solid colors, woodgrains and specialty finishes available and specialty finishes.
- Available in .063" (nominal) extruded aluminum.
- System testing with CA & FL stamps: ASTM E2768/E84, ASTM E136, AAMA 1402
- Class "A" Fire Rating
- Paint finish testing: AAMA 2604
- 1/2" deep, 6" coverage
- 3/4" long stainless steel clips- allows for thermal expansion
- Standard panel length is 24'-0"
- Lengths less than 24'-0" available upon request
- See Plank Extrusions & Accessories Line Card for additional components

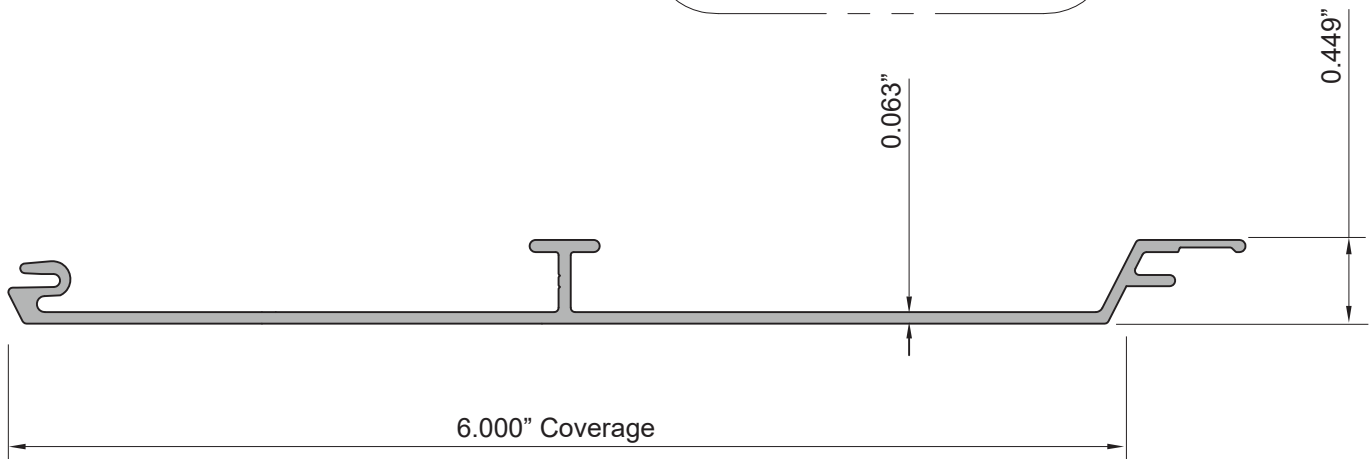
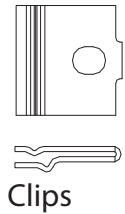
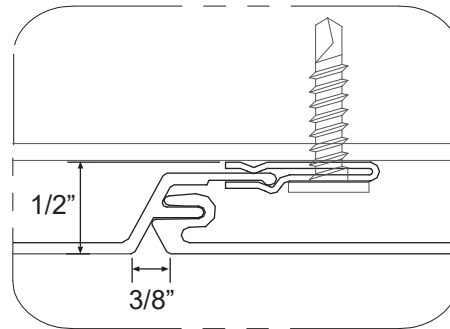
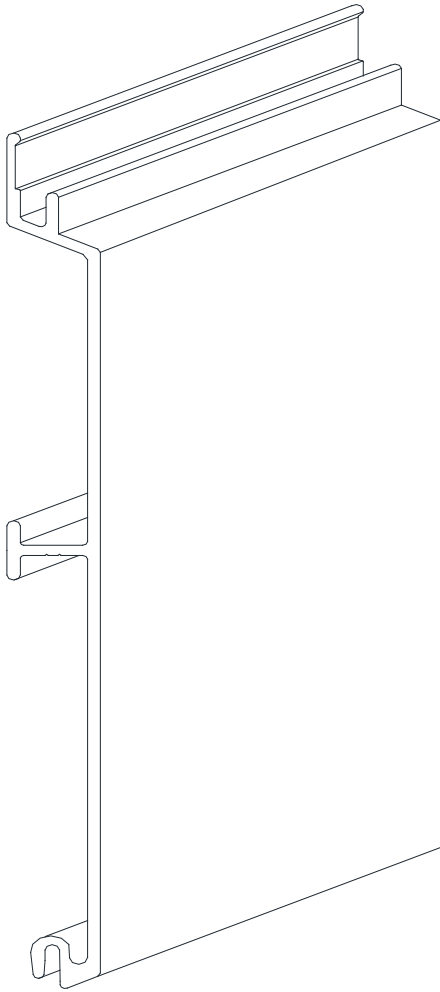

6" Plank