

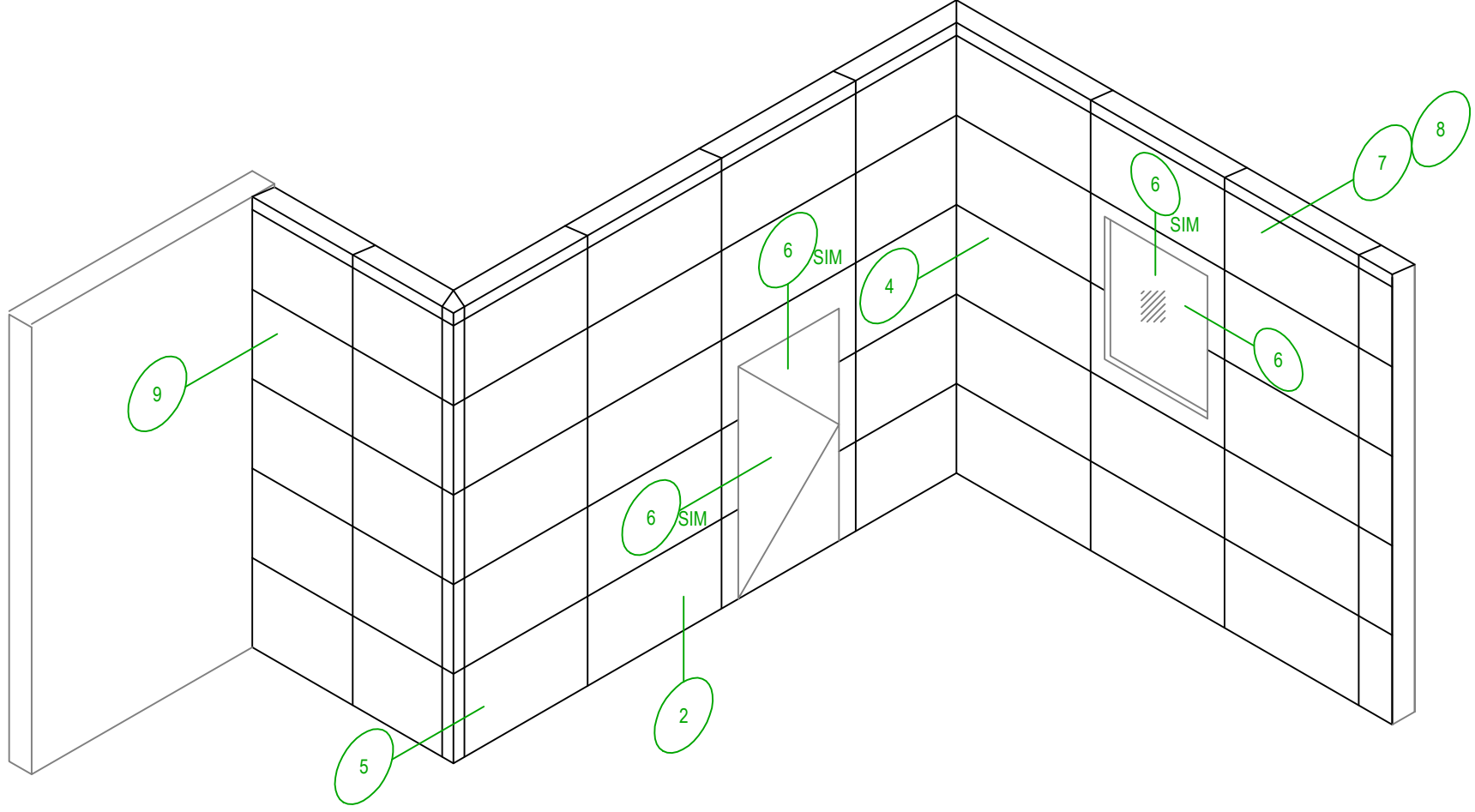

ACM SERIES A2000 Wet Seal Rainscreen





2529 W. Jackson St.
 Phoenix, AZ 85298
 PHONE: (602) 275-1676
 FAX: (602) 275-1739



ACM DETAIL ELEVATION

SCALE: NTS

8/6/14

SYSTEM = 4MM A2000

E

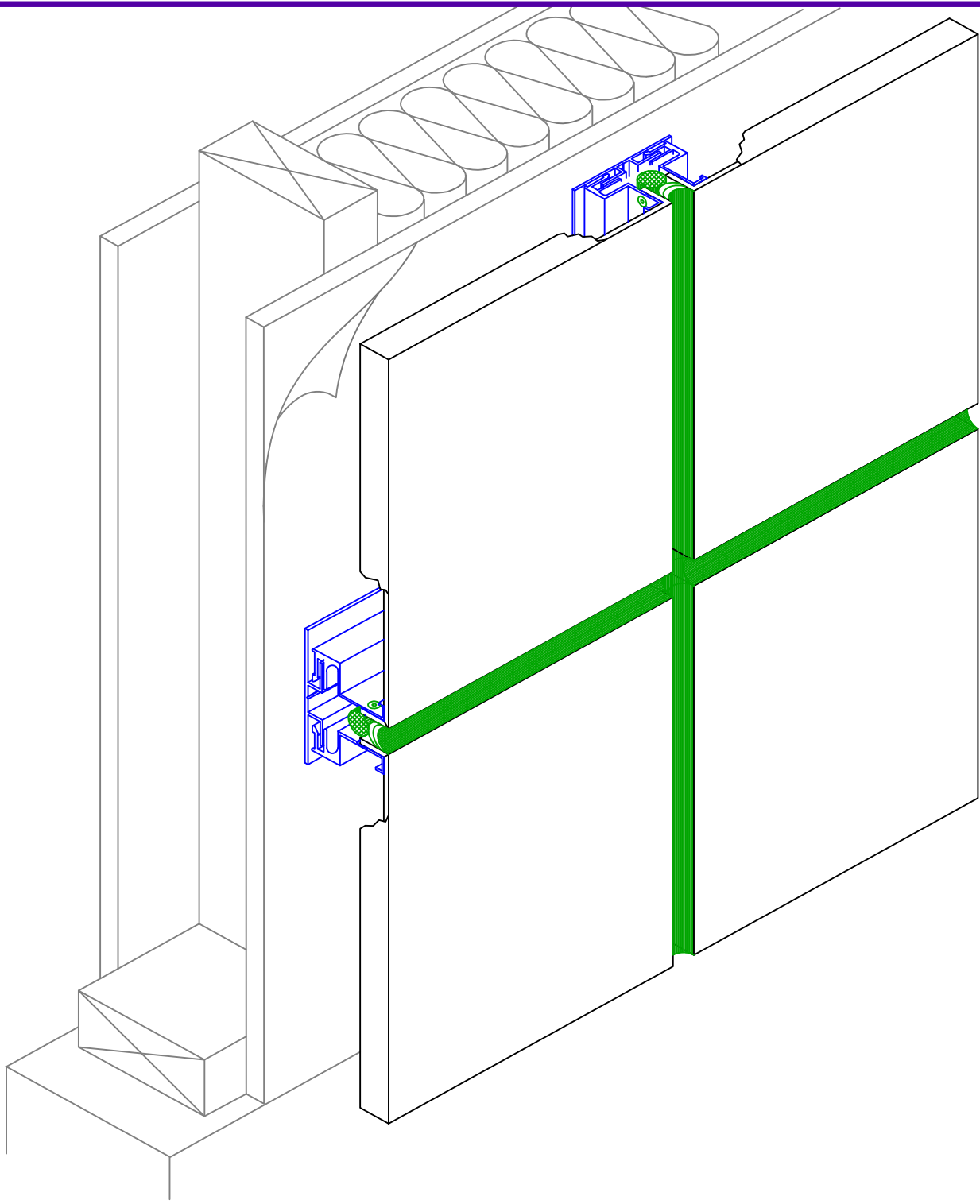

2529 W. Jackson St.
Phoenix, AZ 85298
PHONE: (602) 275-1676
FAX: (602) 275-1739



PANEL ISOMETRIC SKETCH

SCALE: NTS

8/6/14

SYSTEM = 4MM A2000

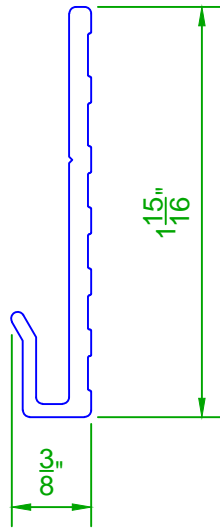

END CLIP EXTRUSION

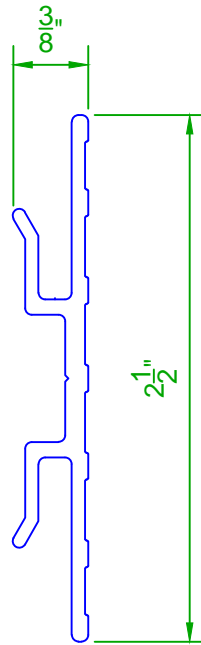

FIELD CLIP EXTRUSION

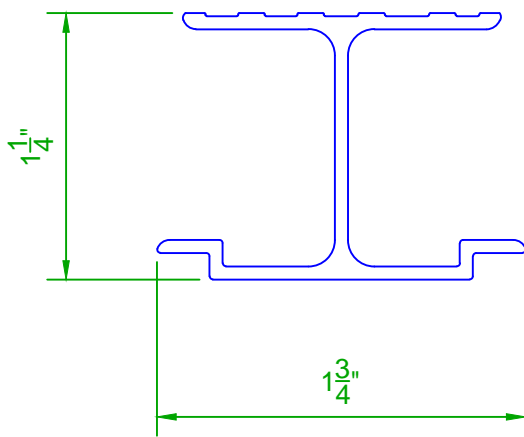

STIFFENER EXTRUSION

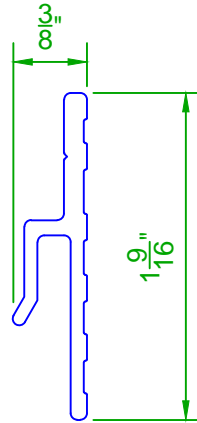

END CLIP EXTRUSION

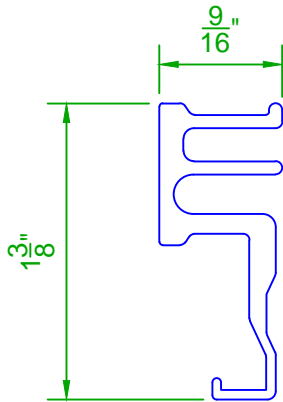

4MM FRAME EXTRUSION

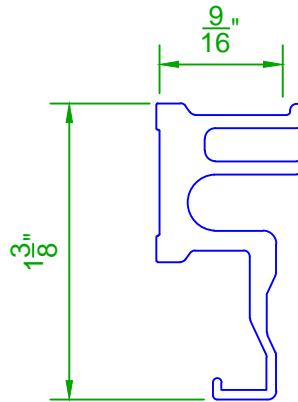

6MM FRAME EXTRUSION



2529 W. Jackson St.
Phoenix, AZ 85298

PHONE: (602) 275-1676
FAX: (602) 275-1739

TYPICAL SYSTEM EXTRUSIONS

SCALE: NTS

8/6/14

SYSTEM = 4MM A2000

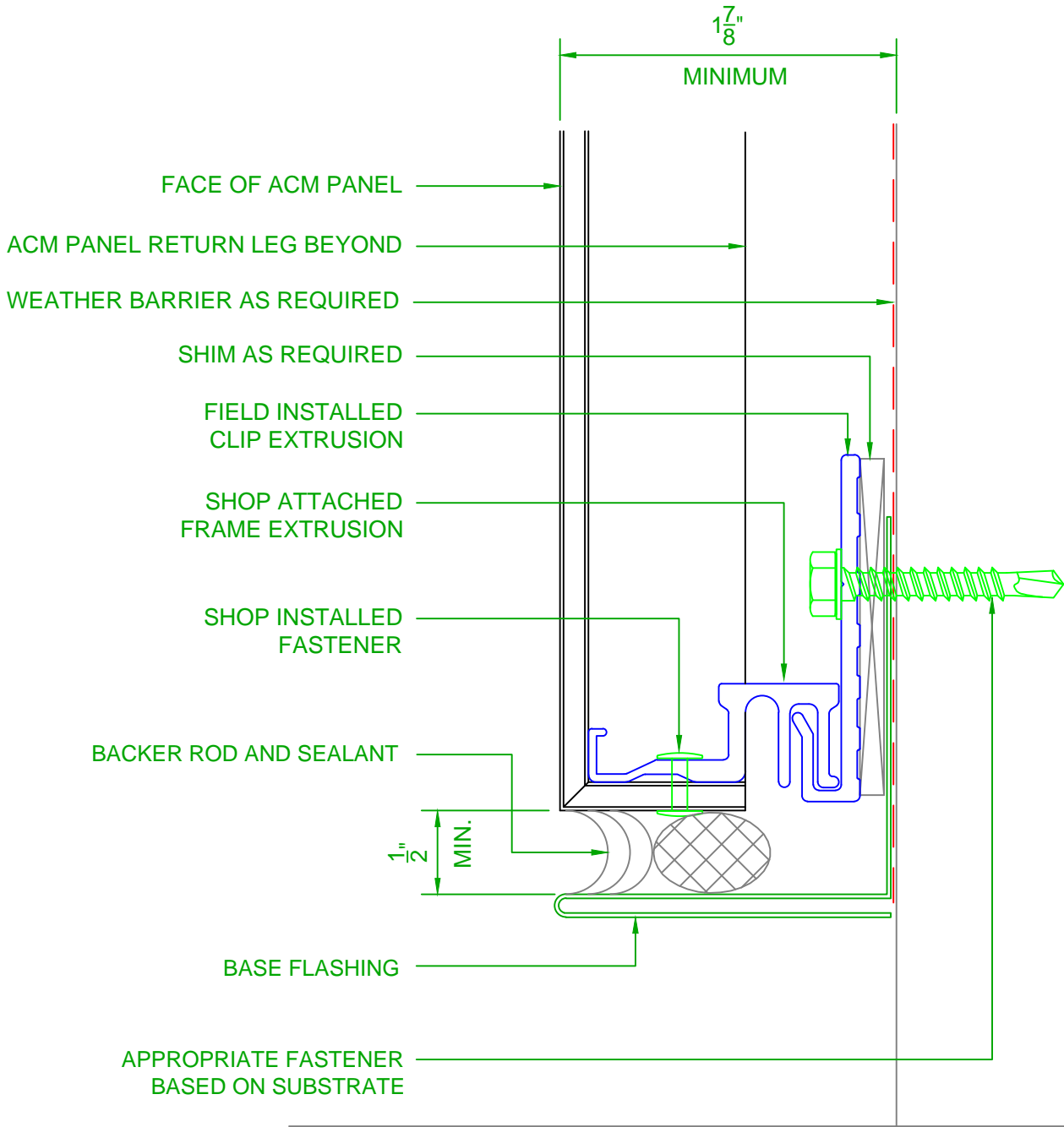

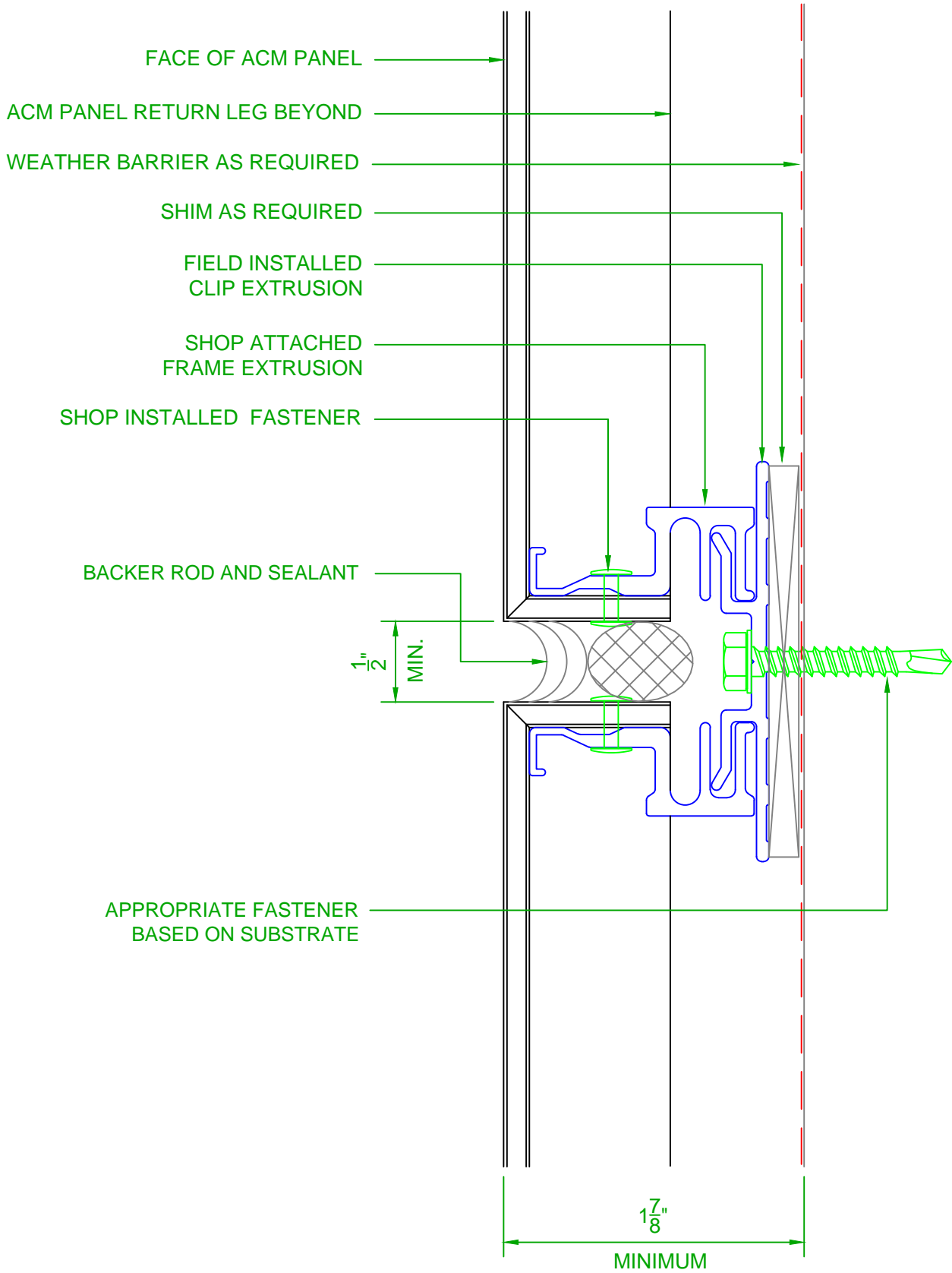

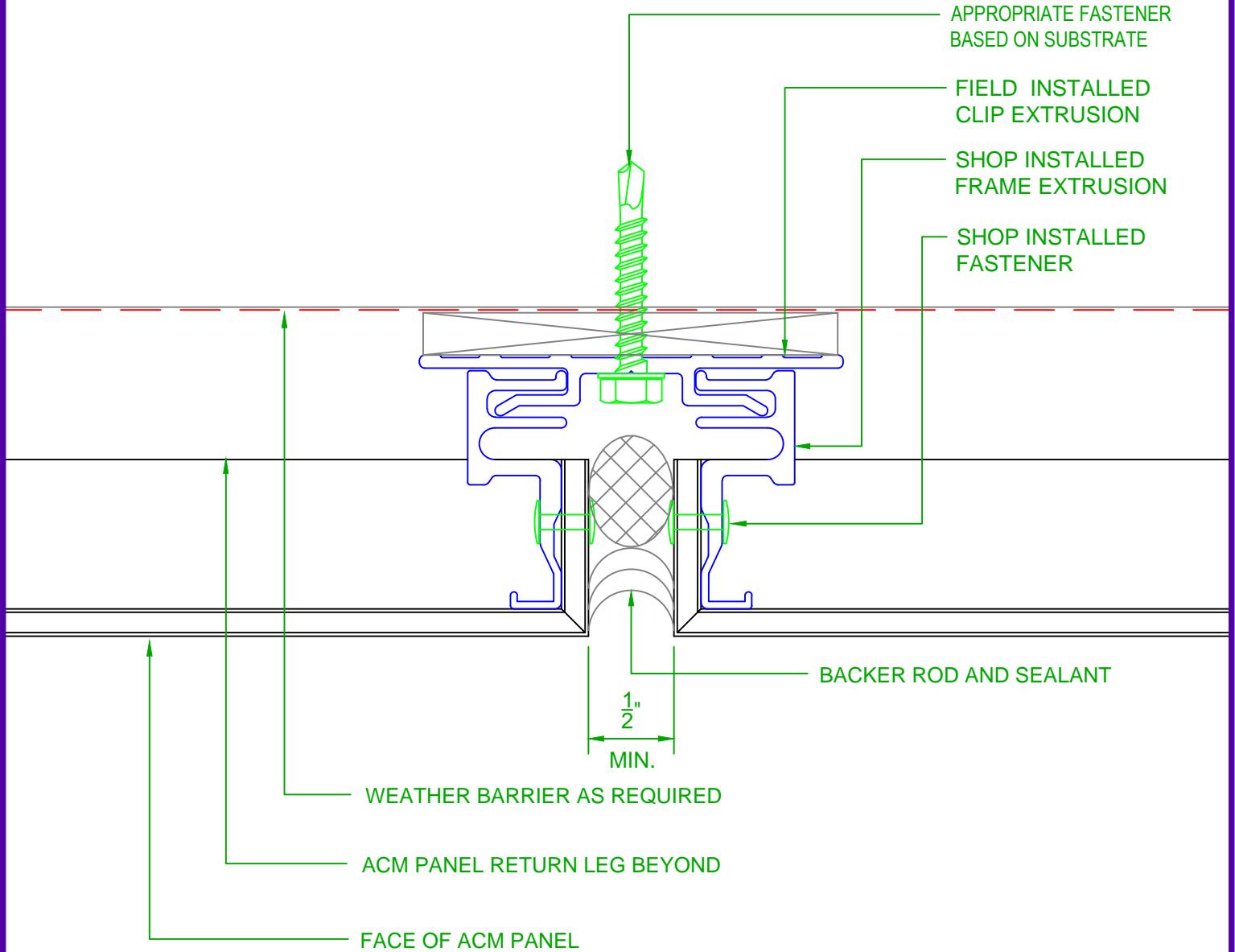

2529 W. Jackson St.
 Phoenix, AZ 85298

PHONE: (602) 275-1676
 FAX: (602) 275-1739

TYP VERTICAL REVEAL

SCALE: NTS

8/6/14

SYSTEM = 4MM A2000

3A

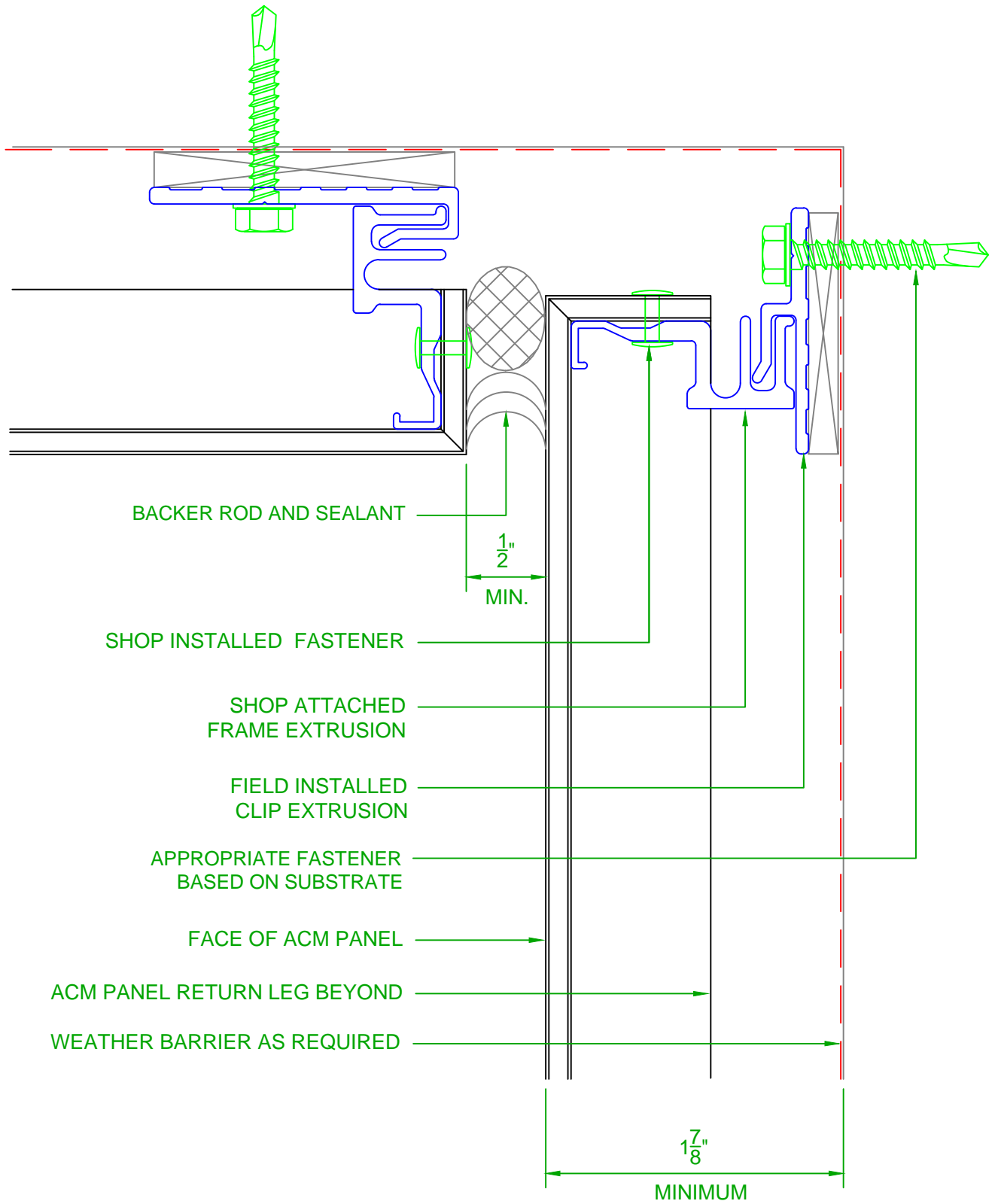

TYP. OUTSIDE CORNER DETAIL

SYSTEM = 4MM A2000

8/6/14

SCALE: NTS

2529 W. Jackson St.
Phoenix, AZ 85298

PHONE: (602) 275-1676

FAX: (602) 275-1739



BACKER ROD AND SEALANT

SHIM AS REQUIRED

APPROPRIATE FASTENER
BASED ON SUBSTRATE

1/2"
MIN.

FIELD INSTALLED
CLIP EXTRUSION

SHOP ATTACHED
FRAME EXTRUSION

SHOP INSTALLED FASTENER

FACE OF ACM PANEL

ACM PANEL RETURN LEG BEYOND

WEATHER BARRIER AS REQUIRED

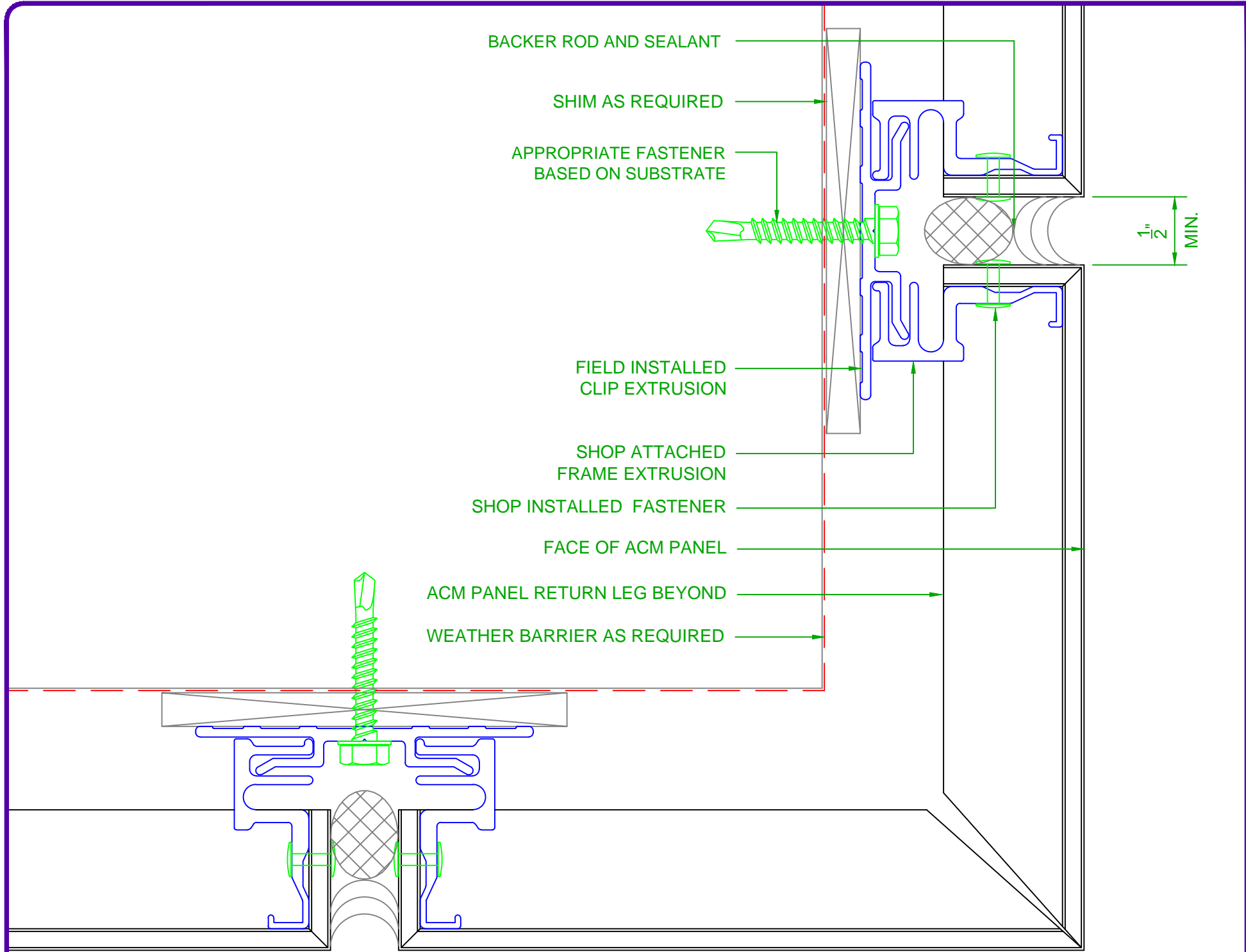

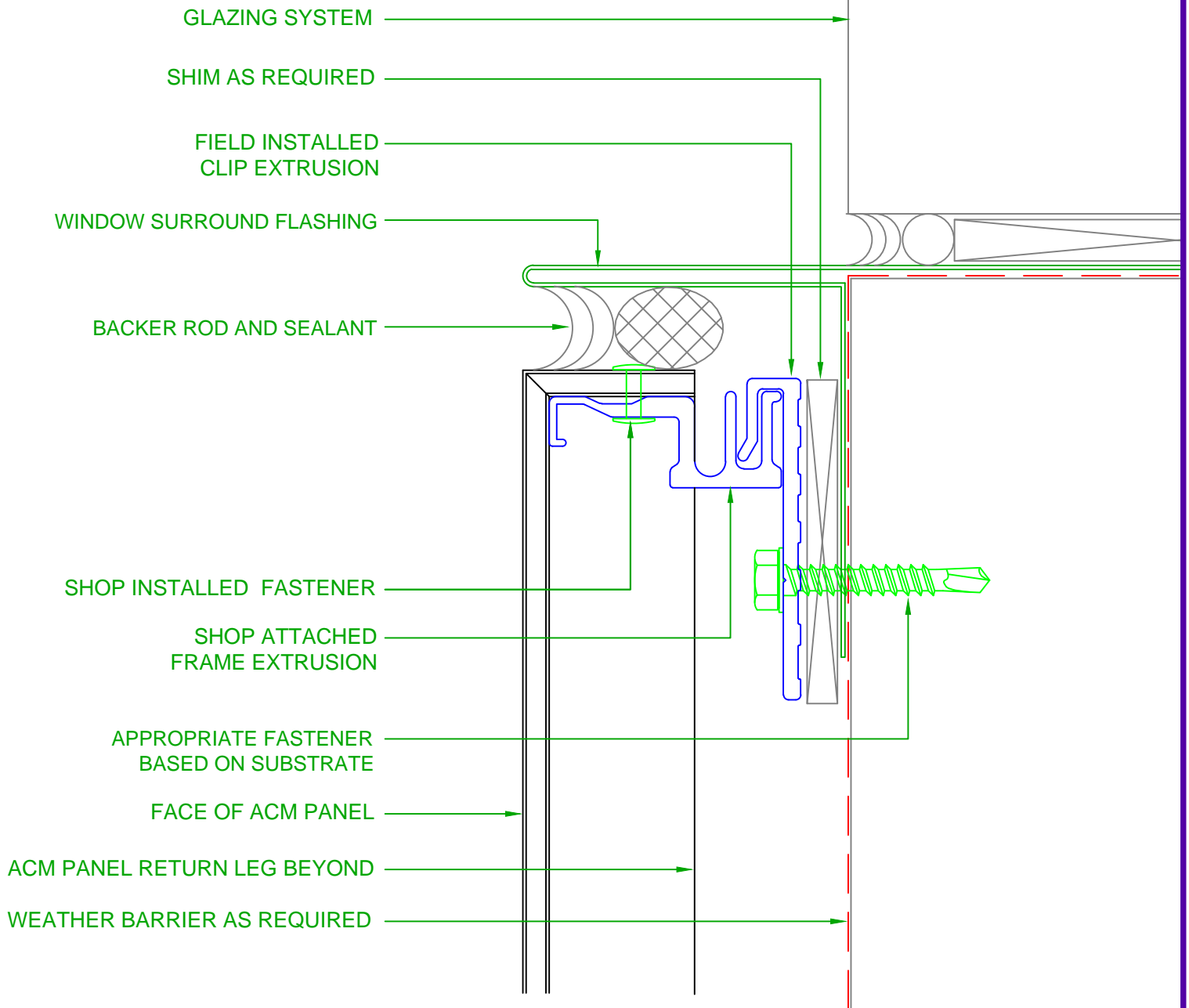

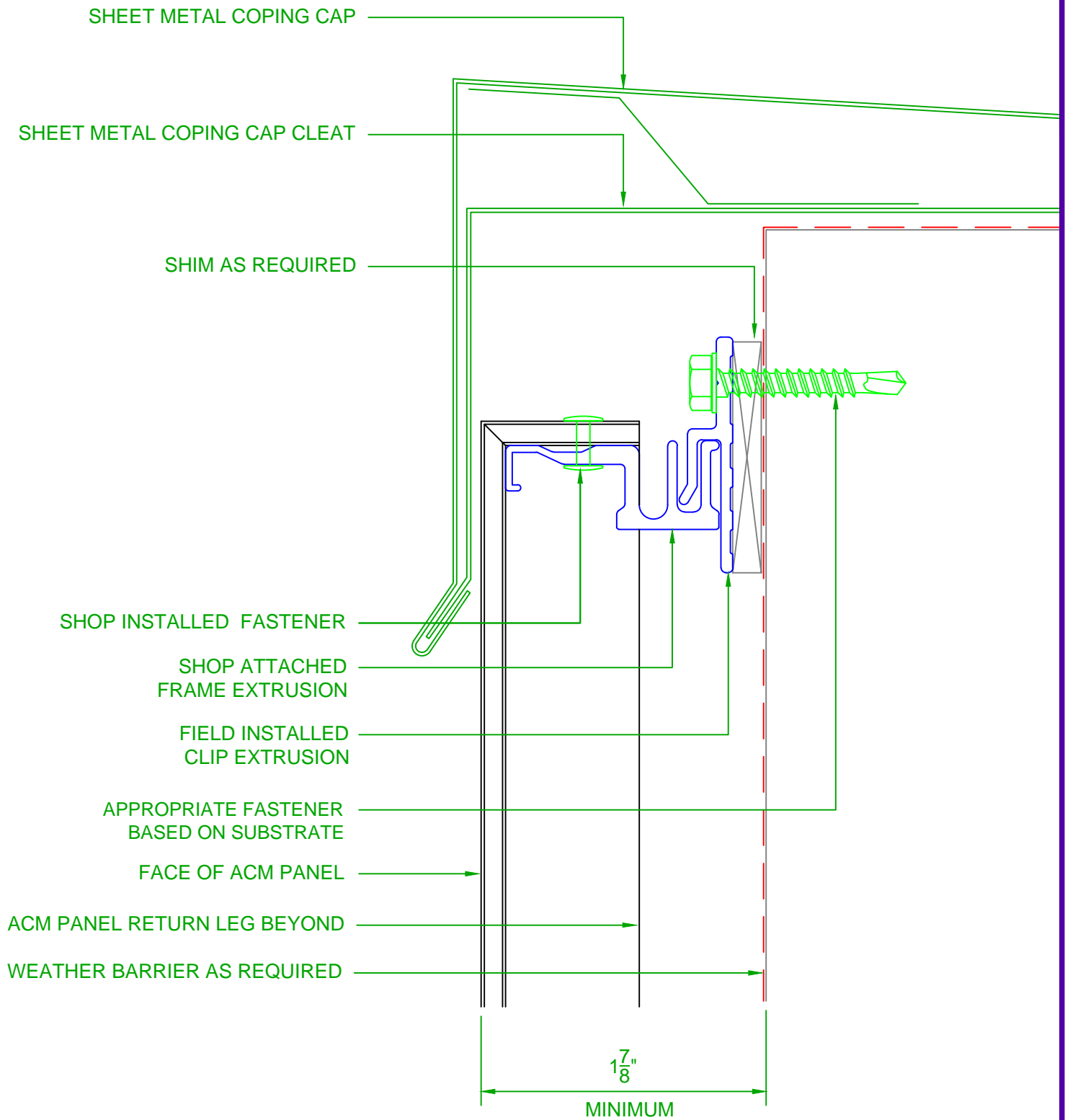

TYP. ACM COPING CAP DETAIL

SYSTEM = 4MM A2000

8/6/14

SCALE: NTS

2529 W. Jackson St.
Phoenix, AZ 85298
PHONE: (602) 275-1676
FAX: (602) 275-1739

